

# MISUTONIDA

italian style accessories **4x4**

## JEEP COMPASS



Item Code

**GP/205/IX**

Codice Articolo

**: GPO/205/IX**

Référence Article

**DSP/205/IX**

**GB**

STAINLESS STEEL GRAND PEDANA  
OVAL GRAND PEDANA















**ITA**

GRAND PEDANA/ GRAND PEDANA  
OVALE IN ACCIAIO INOX

**FR**

GRAND PEDANA/ GRAND PEDANA  
OVALE EN ACCIER INOX

# JEEP COMPASS

Part List Lista della bulloneria Liste des pièces			
<b>A</b>	 <b>TE 10X50</b> x 4	<b>M</b>	 <b>S/205A/DX</b> x 1
<b>B</b>	 <b>M 10</b> autoblocking autobloccante autobloquante x 4	<b>N</b>	 <b>S/205A/SX</b> x 1
<b>C</b>	 <b>CAV 181</b> x 2	<b>O</b>	 <b>S/205P/DX</b> x 1
<b>D</b>	 <b>M 8</b> x 4	<b>P</b>	 <b>S/205P/SX</b> x 1
<b>E</b>	 <b>Ø 8</b> x 4		
<b>F</b>	 <b>Ø 8</b> x 4		
<b>G</b>	 <b>P/48</b> x 2		
<b>H</b>	 <b>Ø 10</b> x 2		
<b>I</b>	 <b>Ø 10</b> x 2		
<b>L</b>	 <b>M 10</b> x 2		

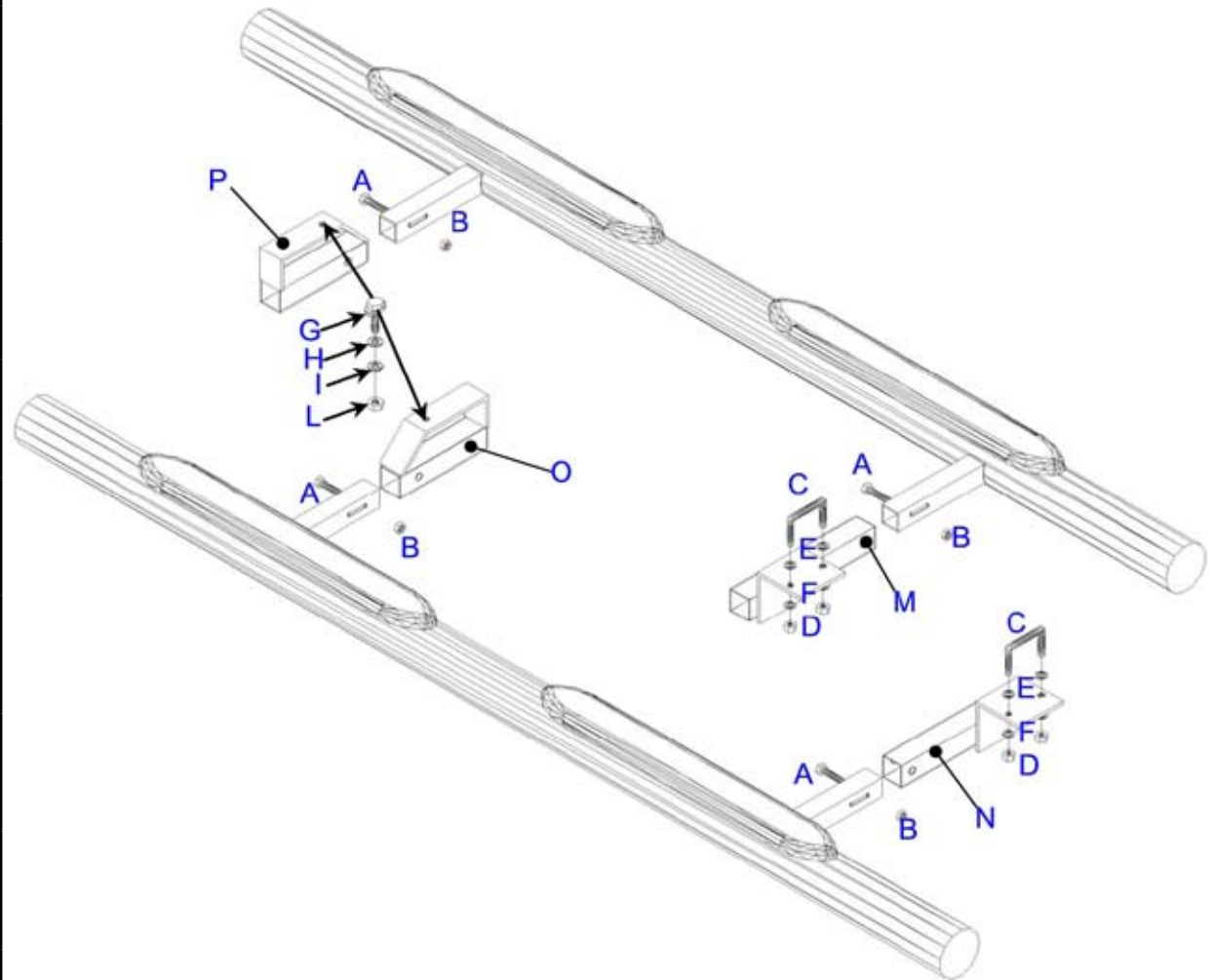

 **MISUTONIDA**  
  *italian style* **4x4**  
*accessories*

**GB**

## FITTING INSTRUCTIONS

### FRONT SIDE

1. Insert **C** in the holes shown in picture 1 and make it come out as shown in picture 2.
2. Fit **N** and **M** on **C** using **E,F,D** (picture 3).

### REAR SIDE

3. Insert **G** in the hole shown in picture 4 and make it come out as shown in picture 5.
4. Fit **P** and **O** as shown in picture 6 using **H,I,L**.
5. Tighten all the set of bolts.

**ITA**

## ISTRUZIONI DI MONTAGGIO

### PARTE ANTERIORE

1. Inserire **C** nei fori indicati in foto 1 e farla fuoriuscire come indicato in foto 2.
2. Montare i supporti **N** e **M** sulle cavallette appena montate utilizzando **E,F,D** foto 3.

### PARTE POSTERIORE

3. Inserire **G** nel foro indicato in foto 4 e farlo fuoriuscire come indicato in foto 5.
4. Fissare i supporti **P** e **O** come indicato in foto 6 utilizzando **H,I,L**.
5. Serrare tutta la bulloneria.

**FR**

## INSTRUCTIONS DE MONTAGE

### PARTIE ANTERIEURE

1. Insérer **C** dans les trous indiqués dans la photo 1 et les faire sortir comme indiqué dans la photo 2.
2. Monter **N** et **M** sûr **C** en utilisant **E,F,D** (photo 3)

### PARTIE POSTERIEURE

3. Insérer **G** dans le trou indiqué dans la photo 4 et le faire sortir comme indiqué dans la photo 5.
4. Fixer **P** et **O** comme indiqué dans la photo 6 en utilisant **H,I,L**.
5. Serrer toute la boulonnerie.

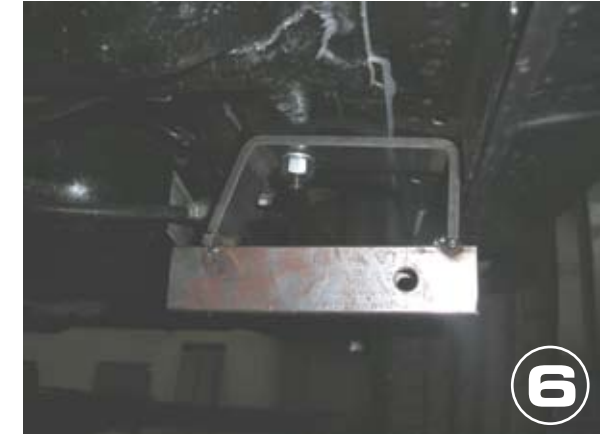

Date Data Date	Item Code Cod.Articolo Réf. Article	Vehicle model Modello Veicolo Modèle de Voiture
28/06/07	GP/205/IX GPO/205/IX DSP/205/IX	JEEP COMPASS

Checked and approved by  
**Controllato ed approvato da**  
 Controlé et approuvé par

**Botta**  
**Pietro**

**MISUTONIDA**  
 italian style  
 accessories **4x4**