

MISUTONIDA
italian style **4x4**
accessories

MAZDA BT 50

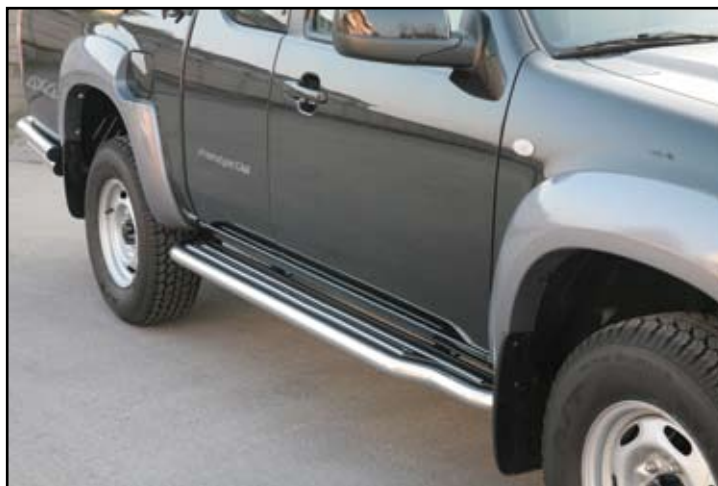

Item Code

Codice Articolo

Référence Article

: **P/195/IX**

GB

STAINLESS STEEL
SIDE STEPS

ITA













PEDANA IN ACCIAIO INOX

FR

MARCHEPIED EN ACCIER INOX

MAZDA BT 50

Part List
 Lista della bulloneria
 Liste des pièces

A		x 2	M		C/42AP/DS	x 2
B		M 10	N		S/42AP/DS	x 2
C		Ø 8	O		S/42P/SX-DX	x 2
D		Ø 8				
E		TE 10X30				
F		Ø 10				
G		Ø 10				
H		TE 10X50				
I		M 10 autoblocking autobloccante autobloquante				x 8
L		P/141A				x 2

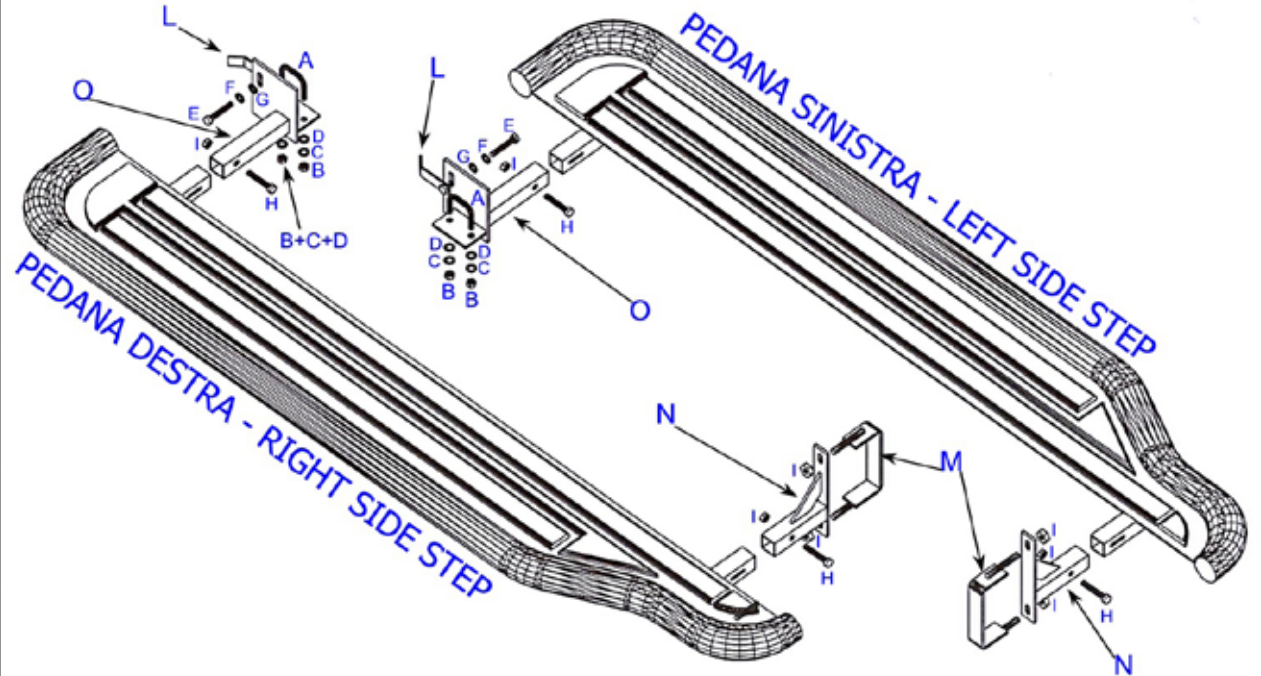

 **MISUTONIDA**
 italian style accessories **4x4**

GB**FITTING
INSTRUCTIONS****REAR SIDE**

1. Use the holes already present on the bodywork to fit A (pictures 1 and 2)
2. Position A as shown in picture 3.
3. Fit M and N as shown in picture 4.
4. Insert L as shown in picture 4 and fix it with E,F,G (picture 5)

FRONT SIDE

5. Fit M on the bodywork
6. Fix N on M using I
7. Fit the sidesteps to the supports.
8. Screw all the set of bolts.

ITA**ISTRUZIONI DI
MONTAGGIO****PARTE POSTERIORE**

1. Utilizzare i fori già presenti sul telaio per montare la cavalletta A (foto 1,2)
2. Posizionare A come indicato in foto 3.
3. Montare M e N come indicato in foto 4.
4. Inserire L come indicato in foto 4 e fissarla con E,F,G (foto 5)

PARTE ANTERIORE

5. Montare M sul telaio
6. Fissare N su M utilizzando I
7. Montare le pedane sui supporti
8. Serrare tutta la bulloneria.

FR**INSTRUCTIONS DE
MONTAGE****PARTIE POSTERIEURE**

1. *Utiliser les trous déjà présents sûr le châssis pour monter A (photos 1 et 2)*
2. *Positionner A comme indiqué dans la photo 3.*
3. *Monter M et N comme indiqué dans la photo 4.*
4. *Insérer L comme indiqué dans laa photo 4 et le fixer avec E,F,G (photo 5).*

PARTIE ANTERIEURE

5. *Monter M sûr le châssis.*
6. *fixer N sûr M en utilisant I.*
7. *Monter les marche pieds sûr les supports .*
8. *Serrer toute la boulonnerie.*



Date Data Date	Item Code Cod.Articolo Réf. Article	Vehicle model Modello Veicolo Modèle de Voiture
22/02/07	P/195/IX	MAZDA BT 50

Checked and approved by
Controllato ed approvato da
Controlé et approuvé par

Botta
Pietro

 **MISUTONIDA**
  *italian style* **4x4**
accessories