

 **MISUTONIDA**
  *italian style* **4x4**
accessories

SSANGYONG KYRON 2007



Item Code

Codice Articolo

Référence Article

: ***P/211/IX***

GB

STAINLESS STEEL
SIDE STEPS





















ITA

PEDANA IN ACCIAIO INOX

FR

MARCHEPIED EN ACCIER INOX

SSANGYONG KYRON 2007

| Part List Lista della bulloneria Liste des pièces | | | |
|--|--|--|-------------------------|
| A  | TE 10X50 x 4 | M  | x 1 |
| B  | M 10 autoblocking autobloccante autobloquante x 4 | N  | M 10 x 2 |
| C  | M 8 x 4 | O  | P/173 x 2 |
| D  | Ø 8 x 4 | P  | M12 x 2 |
| E  | Ø 8 x 4 | Q  | Ø 12 x 2 |
| F  | P/153 x 4 | R  | Ø 12 x 2 |
| G  | P/173A x 4 | S  | S/173P-SX x 1 |
| H  | TE 10X30 Pitch 1,25 Passo 1,25 Pas 1,25 x 2 | T  | S/173P-DX x 1 |
| I  | Ø 10 x 4 | U  | S/173A-SX x 1 |
| L  | Ø 10 x 4 | V  | S/173A-DX x 1 |

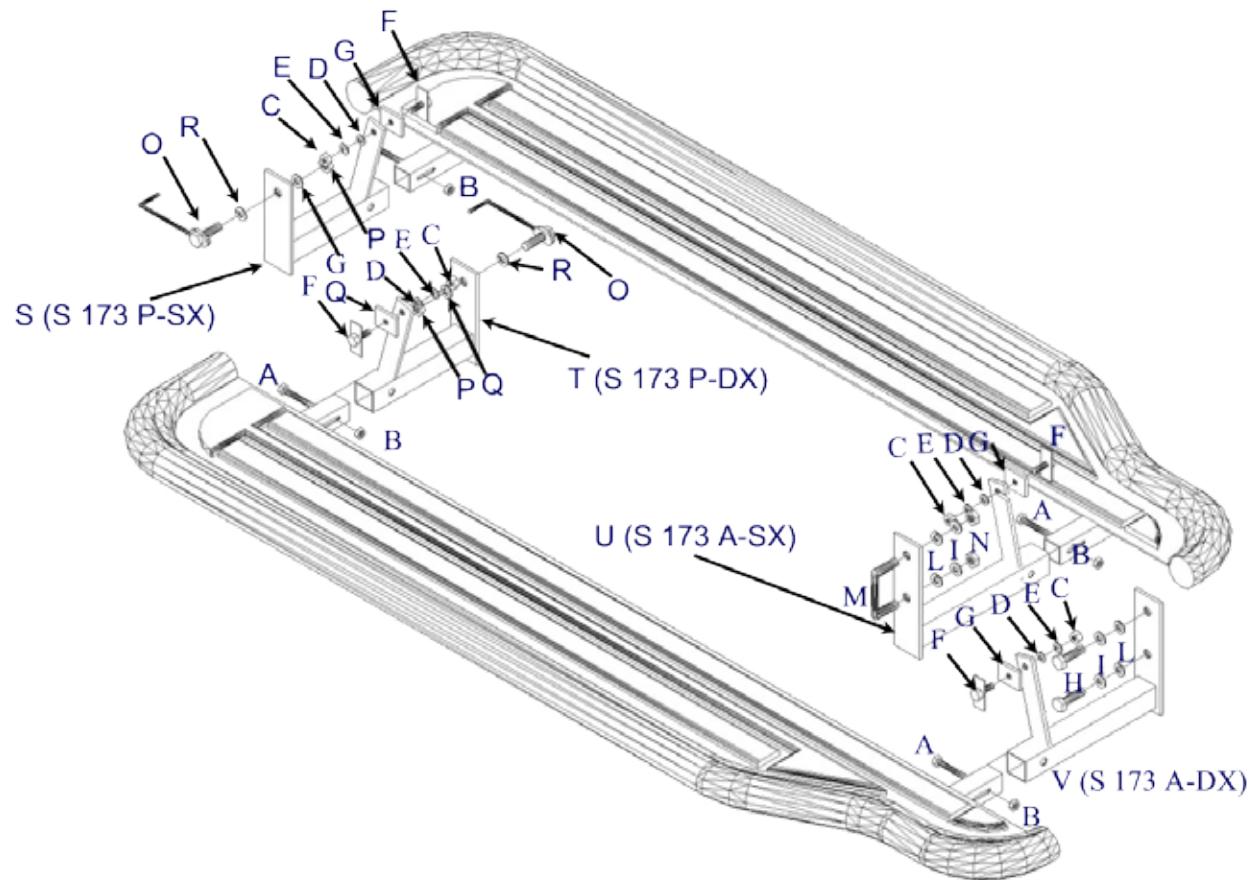

MISUTONIDA
italian style
accessories **4x4**

GB**FITTING
INSTRUCTIONS****FRONT RIGHT SUPPORT**

1. Insert F with G in the bodywork (picture 1)
2. Screw G on F and fix them on the bodywork (picture 2)
3. Position V on F and G in correspondence to the threaded holes already present on the bodywork (picture 3) and fix it using H,I,L and D,C,E.

FRONT RIGHT SUPPORT

4. Repeat the points 1 and 2.
5. Insert M in the bodywork by using the holes already present.
6. Position U on F and G and tighten the support by using N,I,L and C,D,E.

REAR RIGHT AND LEFT SUPPORTS

7. Repeat the points 1 and 2.
8. Insert O in the bodywork (pictures 4 and 5)
9. Position S and T on F,G and O and fix them by using C,D,E and P,Q,R

FIX THE SIDESTEP by using A,B.**ITA****ISTRUZIONI DI
MONTAGGIO****SUPPORTO ANTERIORE DESTRO**

1. Inserire F con G nel telaio (foto 1)
2. Avvitare G su F fissandoli al telaio (foto 2)
3. Posizionare V su F e G in corrispondenza dei fori filettati già esistenti sul telaio (foto 3) e fissarlo utilizzando H,I,L e C,D,E.

SUPPORTO ANTERIORE DESTRO

4. Ripetere i punti 1. e 2.
5. Inserire M nel telaio utilizzando i fori già esistenti.
6. Posizionare U su F e G e serrare il supporto utilizzando N,I,L e C,D,E.

**SUPPORTI POSTERIORI DESTRO E
SINISTRO**

7. Ripetere i punti 1. e 2.
8. Inserire O nel telaio (foto 4 e 5)
9. Posizionare S e T su F,G e O e fissarli utilizzando C,D,E e P,Q,R.

FISSARE LA PEDANA USANDO A,B.**FR****INSTRUCTIONS DE
MONTAGE
SUPPORT ANTERIEUR DROIT**

1. *Insérer F avec G dans le châssis (photo 1)*
2. *Visser G sûr F en les fixant au châssis (photo 2)*
3. *Positionner V sûr F et G en correspondance des trous filetés déjà présents sûr le châssis (photo 3) et le fixer en utilisant H,I,L et C,D,E*

SUPPORT ANTERIEUR DROIT

4. *Répéter les points 1 et 2.*
5. *Insérer M dans le châssis en utilisant les trous déjà présents .*
6. *Positionner U sûr F et G et serrer le support en utilisant N,I,L et C,D,E.*

**SUPPORTS POSTERIEURS DROIT ET
GAUCHE**

7. *Répéter les points 1 et 2.*
8. *Insérer O dans le châssis (photos 4 et 5)*
9. *Positionner S et T sûr F,G et O en utilisant C,D,E et P,Q,R.*

FIXER LE MARCHEPIED EN UTILISANT A,B

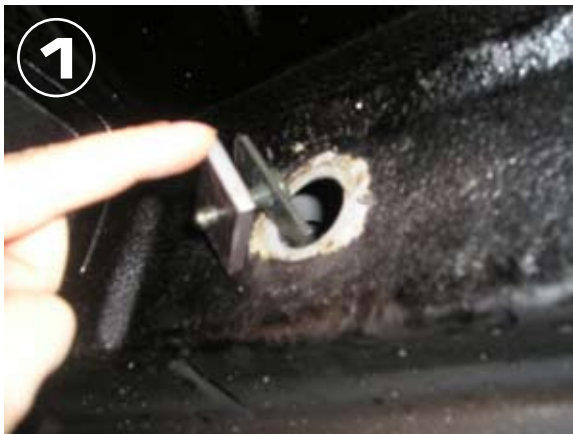

| Date Data Date | Item Code Cod.Articolo Réf. Article | Vehicle model Modello Veicolo Modèle de Voiture |
|----------------------|---|---|
| 28/11/07 | P/211/IX | SSANGYONG KYRON 2007 |

Checked and approved by
Controllato ed approvato da
Controlé et approuvé par

Botta
Pietro

 **MISUTONIDA**
  *italian style* **4x4**
accessories