

**MISUTONIDA**  
*italian style* **4x4**  
*accessories*

**HYUNDAI IX 35**



Item Code

Codice Articolo

Référence Article

: **P/264/IX**

**GB**

**STAINLESS STEEL  
SIDE STEPS**

**ITA**





**PEDANA  
IN ACCIAIO INOX**

**FR**

**MARCHE PIEDS  
EN ACCIER INOX**

# HYUNDAI IX 35

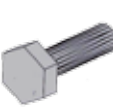
Part List  
 Lista della bulloneria  
 Liste des pièces

<b>A</b>	<b>P/264/D</b> x 2	<b>M</b>	 <b>Ø 6</b> BIG GRANDI GRAND x 4
<b>B</b>	<b>P/264/E</b> x 6	<b>N</b>	 <b>Ø 6</b> x 2
<b>C</b>	<b>Ø 8</b> Big Grandi Grand x 12	<b>O</b>	 <b>M 6</b> x 2
<b>D</b>	<b>Ø 8</b> x 12	<b>P</b>	 <b>TE 8X20</b> x 8
<b>E</b>	<b>M 8</b> x 12	<b>Q</b>	 <b>P/264/A</b> x 2
<b>F</b>	<b>P/264/F</b> x 2	<b>R</b>	 <b>P/264/B</b> x 2
<b>G</b>	<b>Ø 10</b> Big Grandi Grand x 2		<b>Cappelletti M8</b> x 16
<b>H</b>	<b>Ø 10</b> x 2		
<b>I</b>	<b>M 10</b> x 2		
<b>L</b>	<b>TE 6X20</b> x 2		

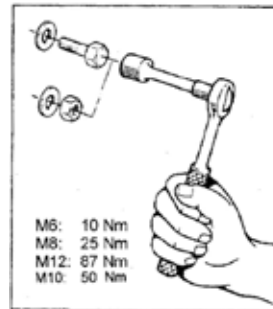
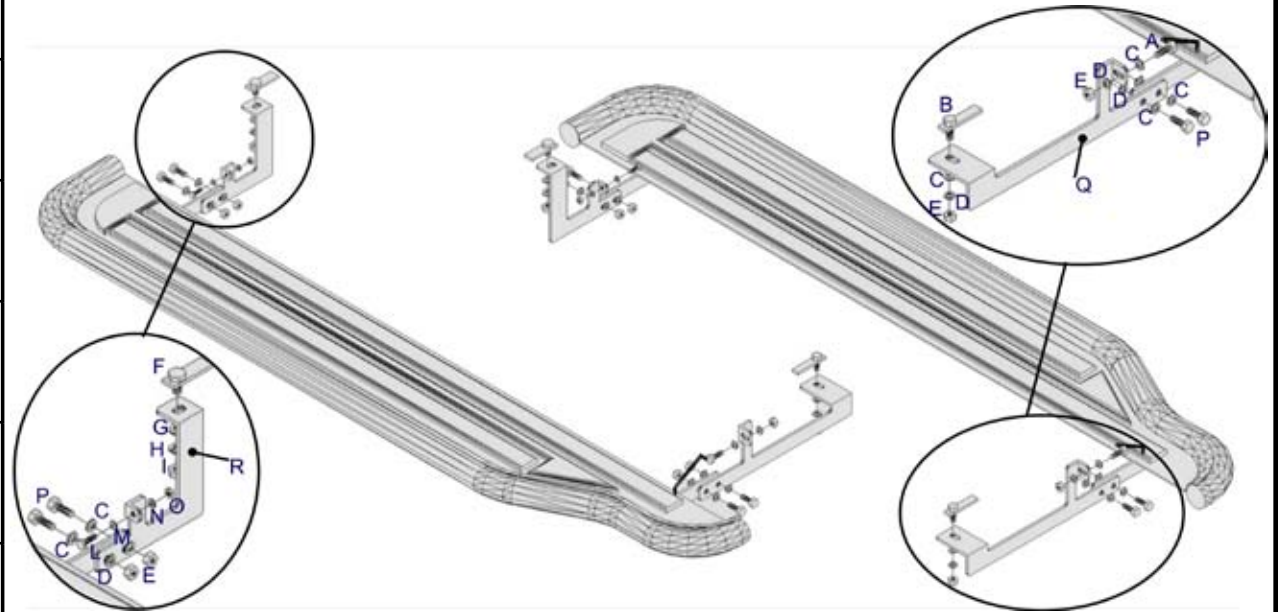

**MISUTONIDA**  
 italian style accessories **4x4**

**GB****FITTING  
INSTRUCTIONS****FRONT SIDE**

1. Remove the plastic cas as shown in pictures 1 and 4.
2. Insert B in the hole shown in pictures 2 and 3.
3. Insert A in the hole shown in picture 5 and make it come out from the hole shown in picture 6.
4. Fit Q on A and B using C,D,E as shown in picture 7.

**REAR SIDE**

5. Remove the plastic cao as shown in picture 8.
6. Insert F in the hole shown in picture 9.
7. Fit R on F and I using G,H,I as shown in picture 10.
8. Fit the accessory more tightly drill a  $\emptyset$  7mm hole in correspondence of the hole located on R (picture 11)
9. Insert L in the hole just drilled as shown in picture 12 and tighten R using M,N,O.
10. To fit the accessory on the Q and R brackets using P,C,D as shown in pictures 14 and 15.
11. Tighten all the set of bolts.

**ITA****ISTRUZIONI DI  
MONTAGGIO****PARTE ANTERIORE**

1. Rimuovere i tappi in plastica come indicato in foto 1 e 4.
2. Inserire B nel foro indicato in foto 2 e 3.
3. Inserire A nel foro indicato in foto 5 e farlo fuoriuscire dal foro indicato in foto 6.
4. Montare il supporto Q su A e B utilizzando C,D,E come indicato in foto 7.

**PARTE POSTERIORE**

5. Rimuovere il tappo in plastica come indicato in foto 8.
6. Inserire F nel foro indicato in foto 9.
7. Montare il supporto R su F utilizzando G,H,I come indicato in foto 10.
8. Per un ulteriore fissaggio praticare un foro  $\emptyset$  7mm in corrispondenza del foro presente sulla staffa R foto 11.
9. Inserire L nel foro appena preticato come indicato in foto 12 e serrare la staffa R utilizzando M,N,O.
10. Montare l'accessorio sulle staffe Q,R utilizzando P,C,D come indicato in foto 14 e 15.
11. Serrare tutta la bulloneria.

**FR****INSTRUCTIONS DE  
MONTAGE****PARTIE ANTERIEURE**

1. *Enlever les bouchons en plastique comme indiqué dans les photos 1 et 4.*
2. *Insérer B dans le trou indiqué dans la photo 3.*
3. *Insérer A dans le trou indiqués dans la photo 5 et le faire sortir du trou indiqué dans la photo 6.*
4. *Monter les pattes de fixation Q sûr A et B en utilisant C,D,E comme indiqué dans la photo 7.*

**PARTIE POSTERIEURE**

5. *Enlever le bouchon en plastique comme indiqué dans la photo 8.*
6. *Insérer F dans le trou indiqué dans la photo 9.*
7. *Monter R sûr F et I en utilisant G,H,I comme indiqué dans la photo 10.*
8. *Pour mieux monter l'accessoire percer un trou  $\emptyset$  7mm en correspondance de ce-lui sûr la patte de fixation R (photo 11).*
9. *Insérer L dans le trou percé comme indiqué dans la photo 12 et serrer la patte de fixation R en utilisant M,N,O.*
10. *Monter l'accessoire sûr les pattes de fixation Q et R en utilisant P,C,D comme indiqué dans les photos 14 et 15.*
11. *Serrer toute la boulonnerie.*

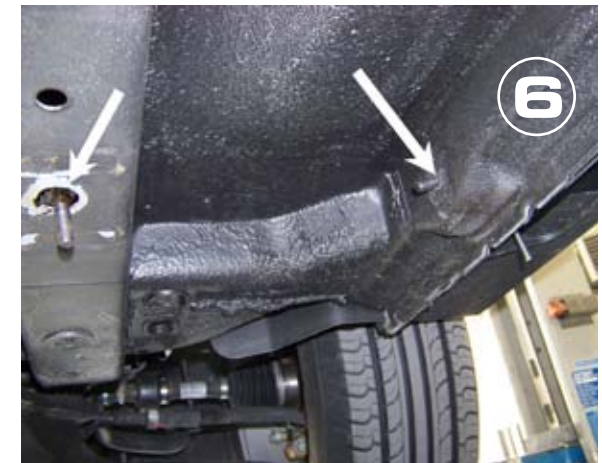
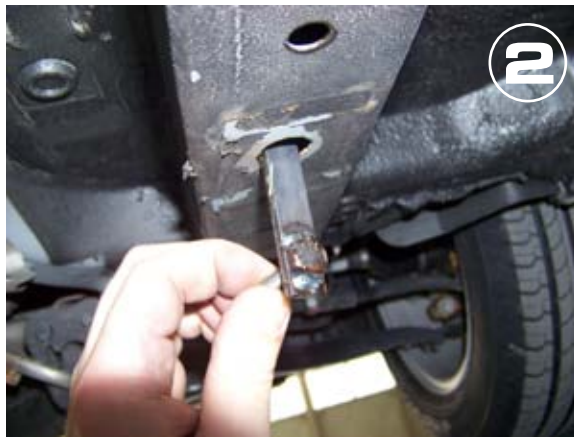

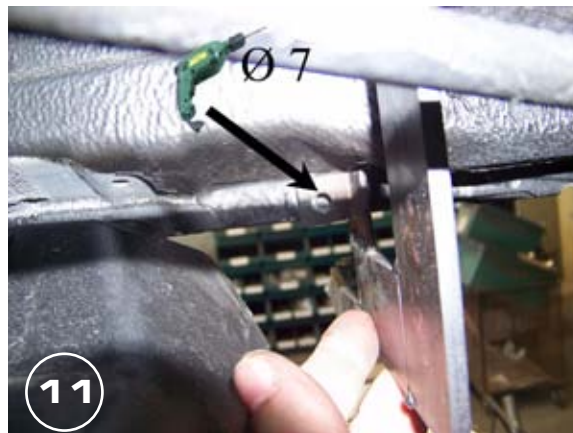

Date Data Date	Item Code Cod.Articolo Réf. Article	Vehicle model Modello Veicolo Modèle de Voiture
16/04/10	P/264/IX	HYUNDAI IX 35

Document checked and approved by  
**Documento controllato ed approvato da**  
 Document contrôlé et approuvé par

**Botta  
 Pietro**

